

# Insekten-Hotel-XXL

Art.-Nr. 92310

  
GARDIGO

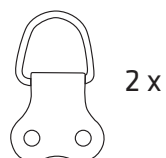
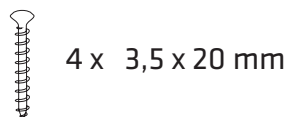
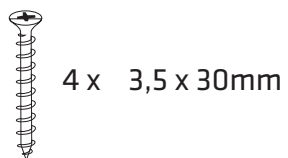
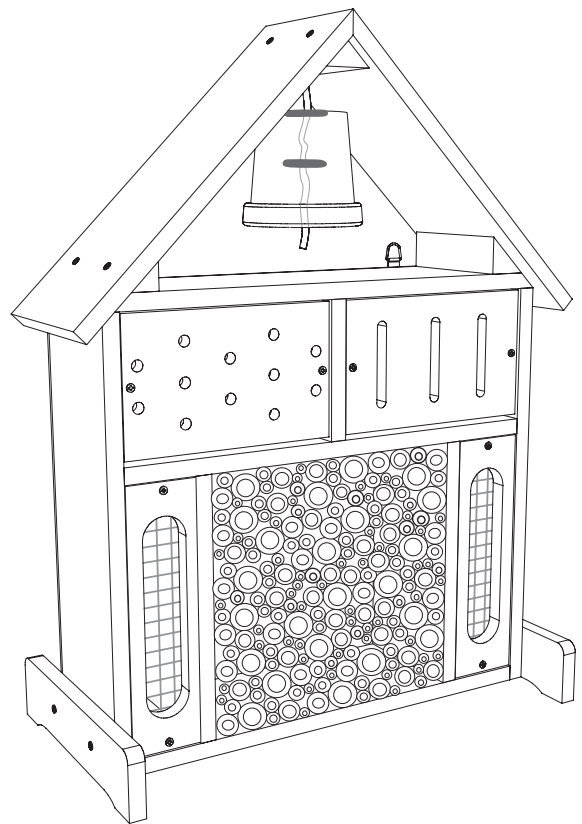
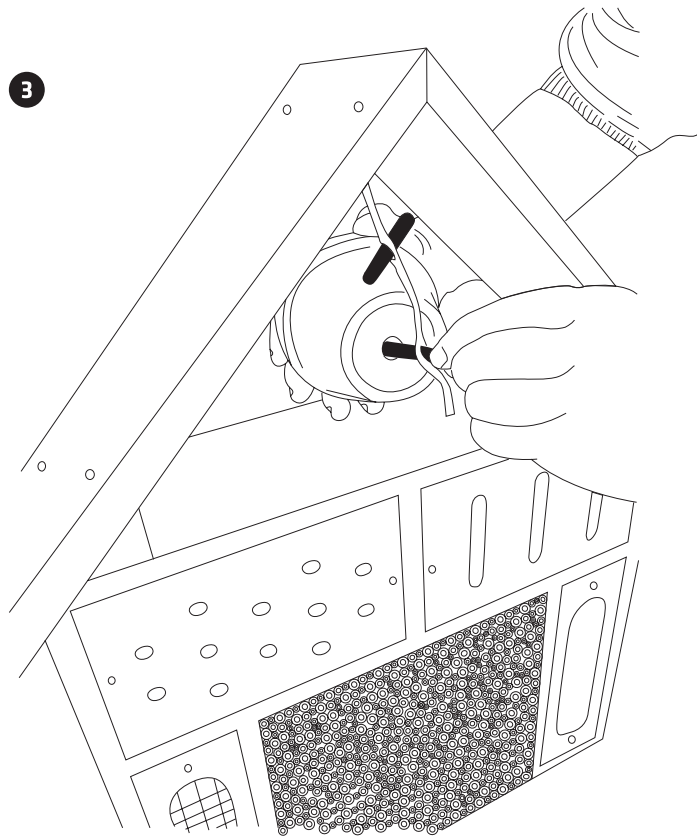
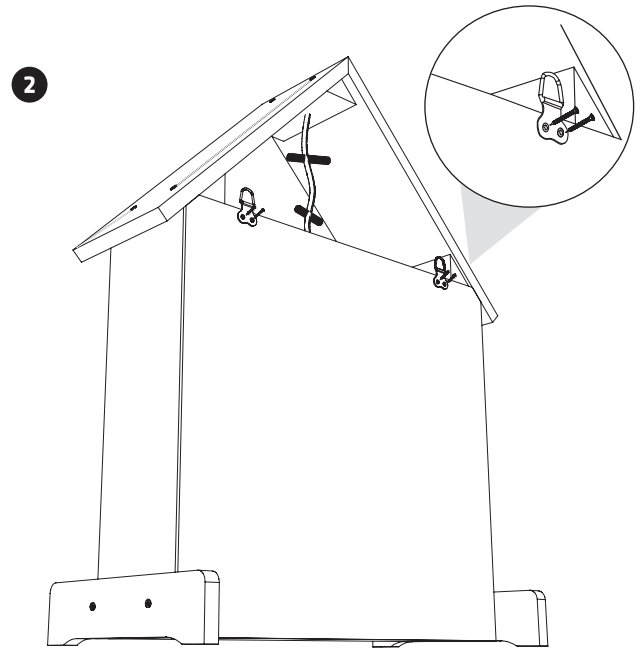
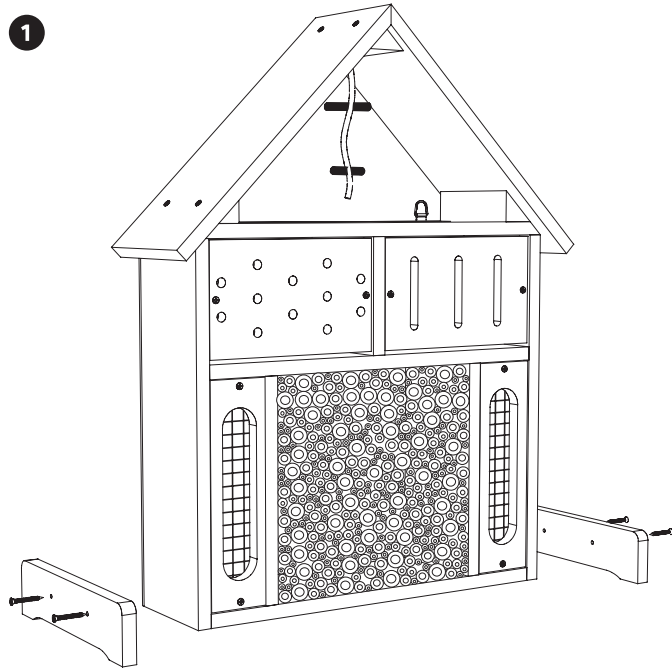

4

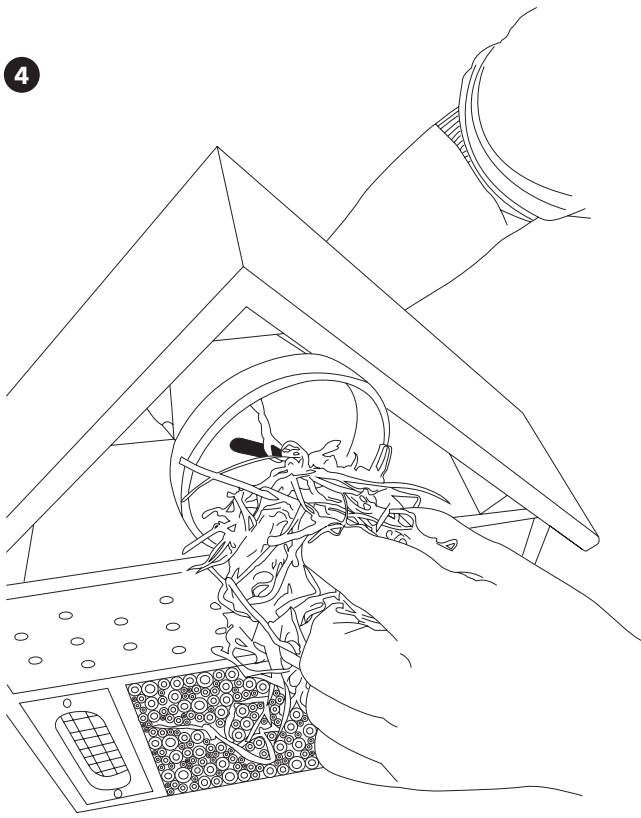

5



6

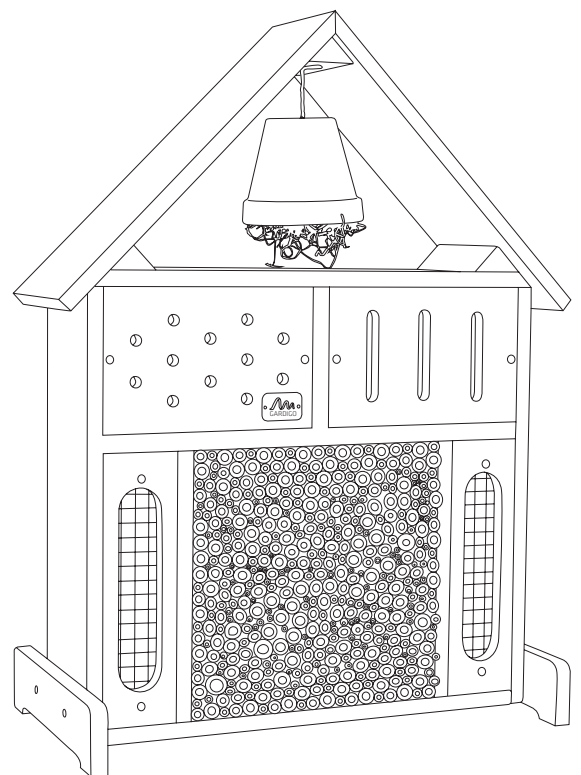
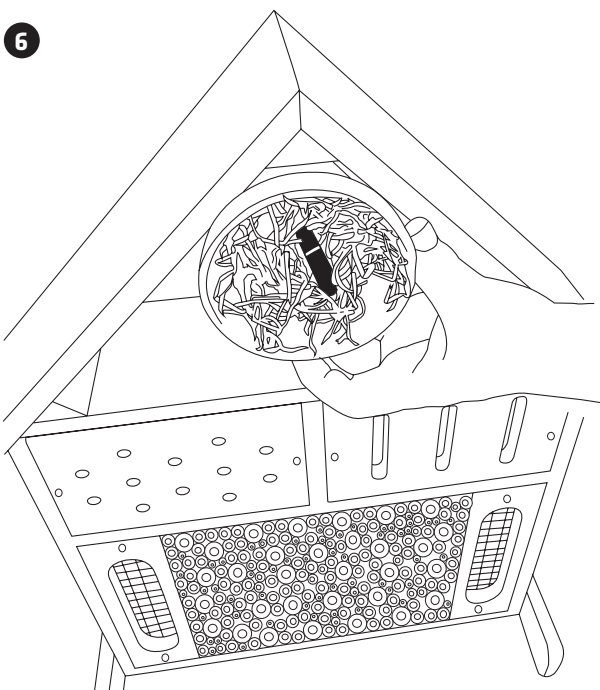

**Hinweis | Note | Remarque | Nota | Indicazione | Opmerking**

- DE** Durch Lagerung und Transport kann Bambus etwas an Volumen verlieren. Das ist ganz normal. Deshalb haben wir diesem Produkt einige zusätzliche Bambus-Röhrchen beigelegt, mit denen eventuelle Lücken geschlossen werden können.
- GB** Bamboo can lose some volume during storage and transport. This is normal. We have included some additional bamboo poles with this product, to allow for closing gaps.
- FR** Le bambou peut perdre du volume en raison du stockage et du transport. C'est tout à fait normal. C'est pourquoi nous avons inclus des tubes de bambou supplémentaires, qui peuvent être utilisés pour combler les lacunes.

- ES** El bambú puede perder algo de volumen durante el almacenamiento y el transporte. Esto es normal. Hemos incluido algunas varas de bambú adicionales con este producto, para permitir cerrar brechas.
- IT** Il bambù può perdere volume durante lo stoccaggio e il trasporto. E' normale. Abbiamo incluso alcuni pali di bambù aggiuntivi con questo prodotto, per consentire di chiudere gli spazi vuoti.
- NL** Bamboe kan wat volume verliezen tijdens opslag en transport. Dit is normaal. We hebben bij dit product enkele extra bamboestokken meegeleverd om kieren te kunnen dichten.