

# MARDER-MATTE MOBIL

Transportabel zusammenfalten für unterwegs



**DE** Zusammenbau der Matte

**GB** Assembly of the mat

**FR** Assemblage du tapis

**ES** Montaje de la alfombrilla

**IT** Assemblaggio del tappetino

**NL** Opbouw van de mat

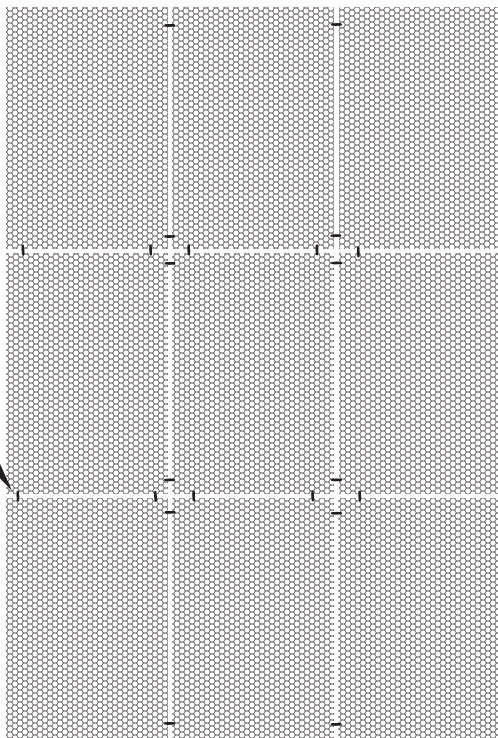
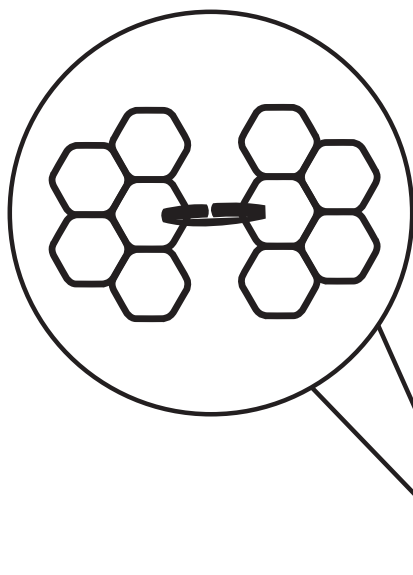

**DE** Zusammenfalten für den Transport

**FR** Pliage pour le transport

**IT** Ripiegamento per il trasporto

**GB** Fold for transport

**ES** Doblar para el transporte

**NL** Opvouwen voor het transport

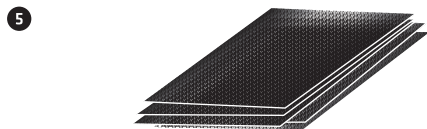
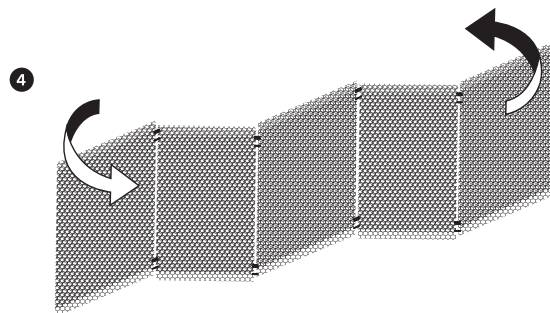
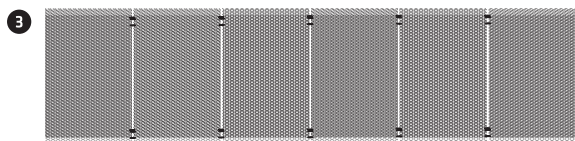
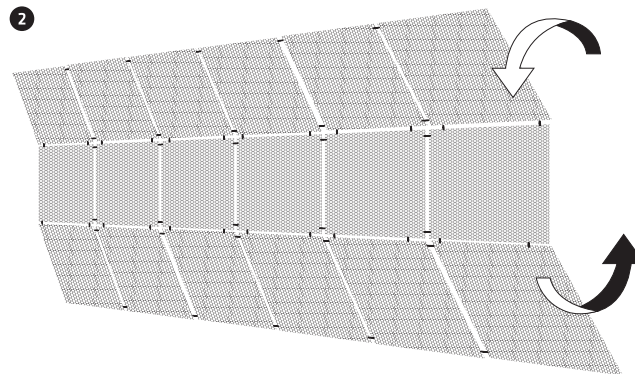
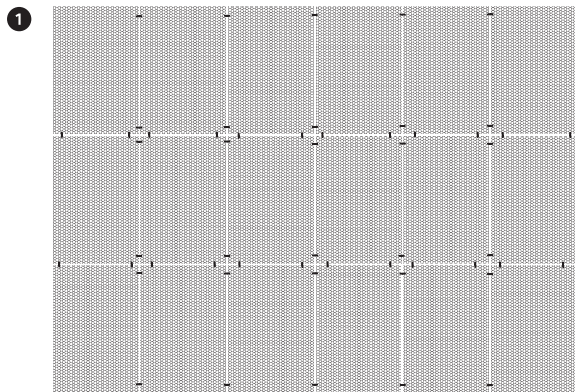

# MOBIL MÅRMÅTTE

---

# MÅRDMATTA MOBIL



**DK** Samling af måtten

**S** Montering av mattan

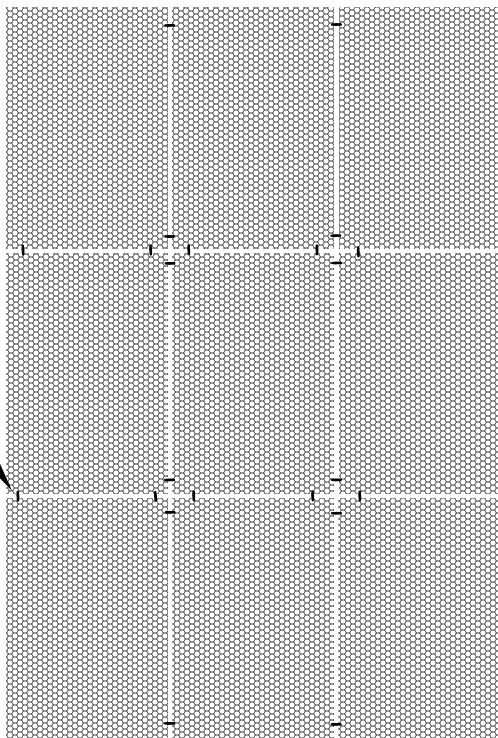
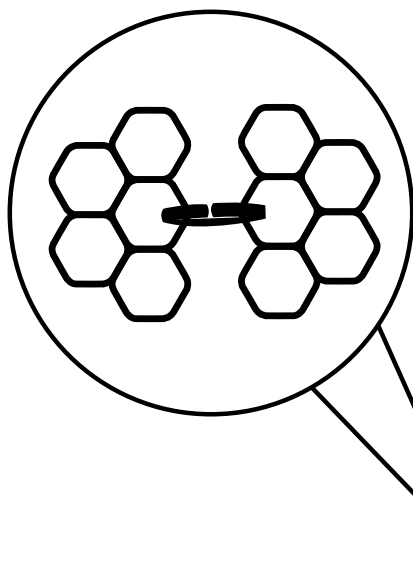

**DK** Sammenfoldning for transporten

**S** Kan vikas ihop för transport

